

L16RNx is a 5" High Fidelity woofer with an injection moulded metal chassis, intended for bass reflex and transmission line designs.

Stiff, yet light aluminum cone and low loss rubber surround show no sign of the familiar 500-1500 Hz cone edge resonance and distortion associated with soft cones.

A bumped back plate in the magnet system, together with the very long and light weight copper clad aluminum voice coil, allow extreme coil excursion with low distortion.

A heavy copper ring below the T-shaped pole piece reduces non linear and modulation distortion.

Extremely stiff and stable injection moulded metal basket, keeps the critical components in perfect alignment. Large windows in the basket both above and below the spider reduce sound reflection, air flow noise and cavity resonance to a minimum.

This driver use Seas SpiderRing® technology.

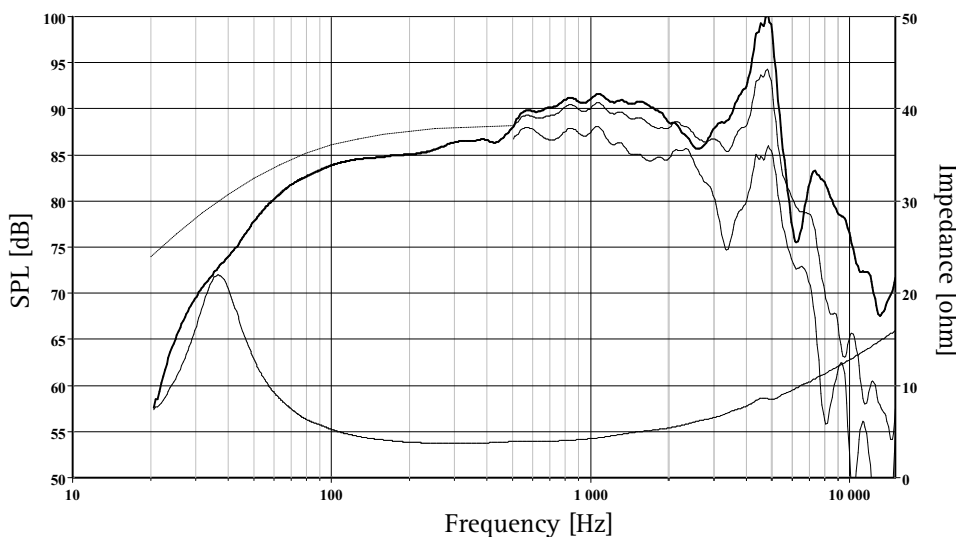

The frequency responses above show measured free field sound pressure in 0, 30, and 60 degrees angle using a 10L closed box. Input 2.83 V<sub>RMS</sub>, microphone distance 0.5m, normalized to SPL 1m. The dotted line is a calculated response in infinite baffle based on the parameters given for this specific driver. The impedance is measured in free air without baffle using a 2V sine signal.

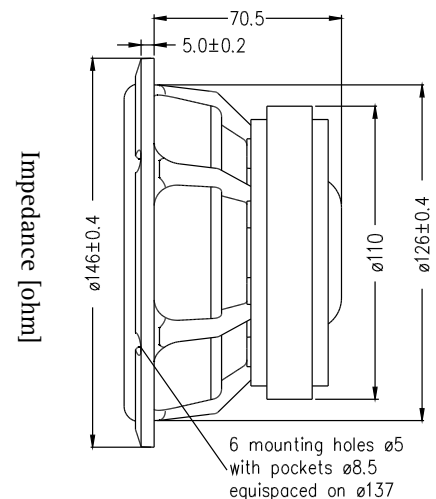

Nominal Impedance	4 Ohms	Voice Coil Resistance	3.1 Ohms
Recommended Frequency Range	45 - 2000 Hz	Voice Coil Inductance	0.32 mH
Short Term Power Handling *	250 W	Force Factor	5.4 N/A
Long Term Power Handling *	80 W	Free Air Resonance	37 Hz
Characteristic Sensitivity (2,83V, 1m)	88 dB	Moving Mass	14.7 g
Voice Coil Diameter	39 mm	Air Load Mass In IEC Baffle	0.62 g
Voice Coil Height	18 mm	Suspension Compliance	1.3 mm/N
Air Gap Height	6 mm	Suspension Mechanical Resistance	1.88 Ns/m
Linear Coil Travel (p-p)	12 mm	Effective Piston Area	104 cm <sup>2</sup>
Maximum Coil Travel (p-p)	22 mm	VAS	16 Litres
Magnetic Gap Flux Density	1.05 T	QMS	2.31
Magnet Weight	0.42 kg	QES	0.38
Total Weight	1.80 kg	QTS	0.33

Dec 2007-1

\*IEC 268-5

SEAS reserves the right to change technical data