

# 45350 I Digital television techniques (5 sp)

- Lectures
  - Mondays 8.30-10, Thursdays 10-12, room B3039
- Exercises (5 exercises, 10 h)
  - During lecture hours
  - Electronic submission (on <https://abacus.abo.fi/ro.nsf/>)
- Exam
  - May 24 2013., OR June 7 2013
- Books:
  - Ulrich Reimers: Digital Video Broadcasting
  - David Gómez-Barquero: Next Generation Mobile Broadcasting (2013)
- Other material
  - Lecture notes
  - Specifications, articles, etc..

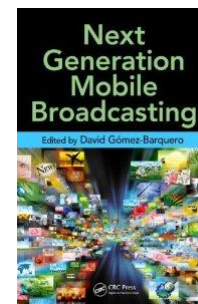
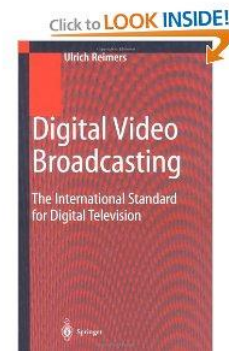

# Digital television techniques

## Wireless communication technology

- Video broadcasting - historical overview
- MPEG-2 video compressing basics (exercise)
- Audio coding
- System / multiplexing
- Modulation and Digital modulation (exercise)
- •Forward error correcting techniques (FEC)
- COFDM-modulation technique (DVB-T/T2, WLAN)
- DVB standardization
- Simulation techniques
- Performance analysis
- SDR approaches

# Digital television techniques

## Introductional lecture:

- \* Television history
- \* Black and white television
- \* Color television
- \* Sound
- \* Progress towards digital television

# Television history

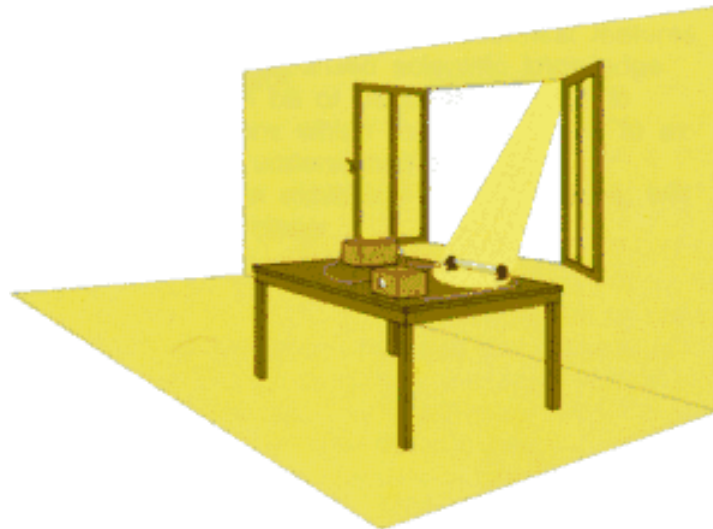

1873 - Resistance of selenium bar changes in light

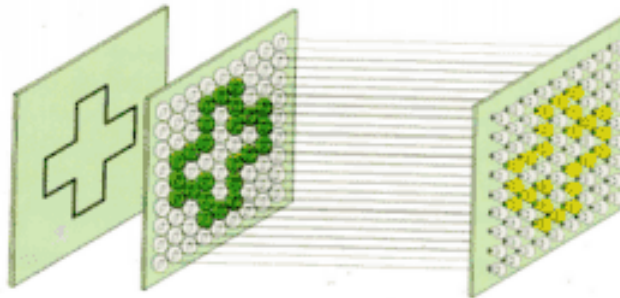

# Basics for television

- Using physiological capabilities of humans
  - Eye will remember for a while
    - 25 screen updates / s
  - Eye/brain will combine dots to a picture
  - Brain will combine a series of still pictures to a continuous motion
  - Color sensing capabilities

## Television history – I Generation

- 1880 First articles appear in Scientific American about the possibility of television.
- 1900 First known use of the word "television" at 1900 Paris Exhibition
- 1907 Boris Rosing (Russia) designs mechanical scanner with CRT receiver
- On January 23, 1926, John Logie Baird (of England) gave the world's first public demonstration of a mechanical television apparatus, license to transmit in London
  - AT&T gives public mechanical television demonstration (USA)

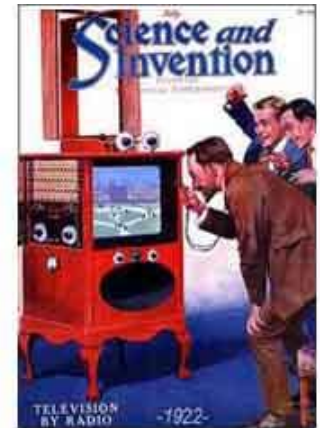

# Baird's Mechanical Television System

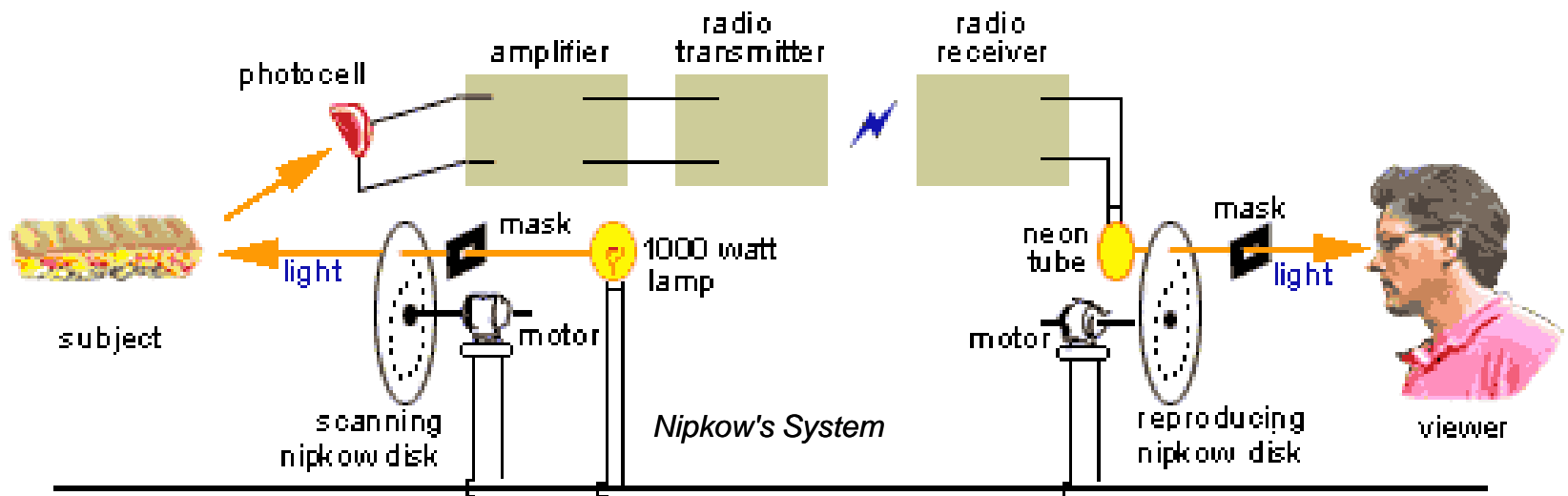

# Electronical system

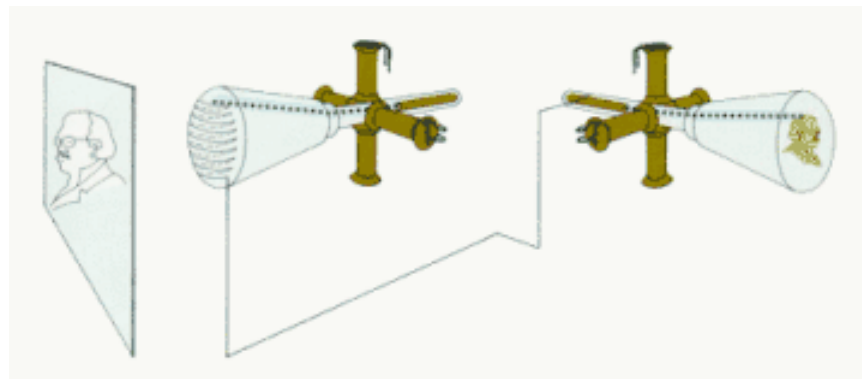



## Television history – II generation – B & W

1928 Takayanagi gives demonstration of CRT

(Cathode Ray Tube) system in Japan

1935 "First television broadcasting system in the World" – Germany

1941 The NTSC announced the recommended USA standard of 525 lines and 30 fps (frames per second).

1946 CBS gave the FCC a demonstration of their mechanical color system

1953 Color TV broadcast begins

1954 RCA first all-electronic TV-set

1956 Time magazine calls color TV "the most resounding industrial flop of 1956"

# Television Now Reality; Device Demonstrated

Secretary Hoover First  
to Make Use of Latest  
Scientific Achievement



HERBERT HOOVER.

*Image of Speaker is  
Carried by Phone  
and Radio.*

**RESULT OF YEARS  
OF EXPERIMENT**

*New York-Washington  
Tests Complete  
Success.*

New York, April 7.—(AP).—Television, a scientists' dream ever since the telephone was invented half a century ago, became an actuality today when Secretary of Commerce Herbert Hoover spoke over the telephone in

# Cathode Ray Tube

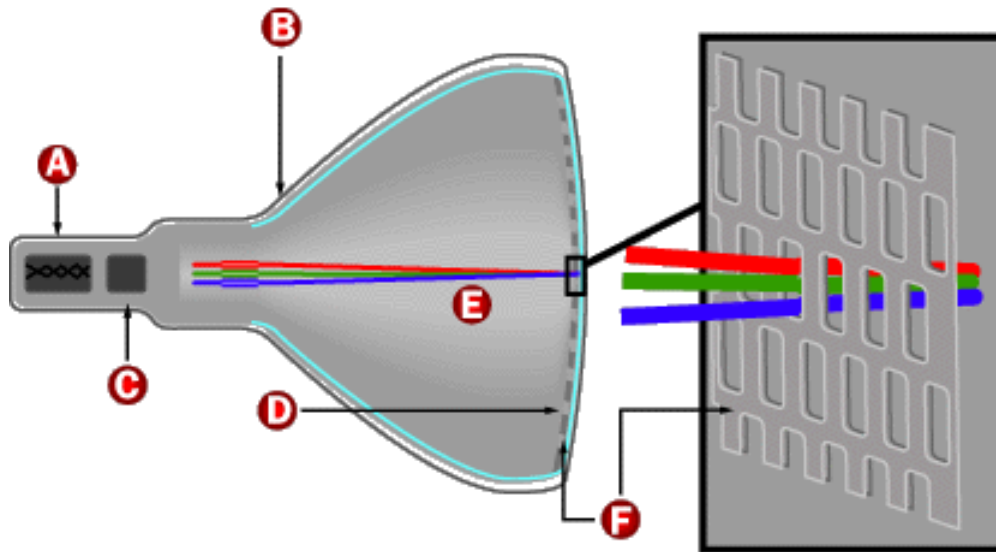

©2000 How Stuff Works

- A** Cathode
- B** Conductive coating
- C** Anode
- D** Phosphor-coated screen
- E** Electron beams
- F** Shadow mask



# The Iconoscope

an early electronic camera tube

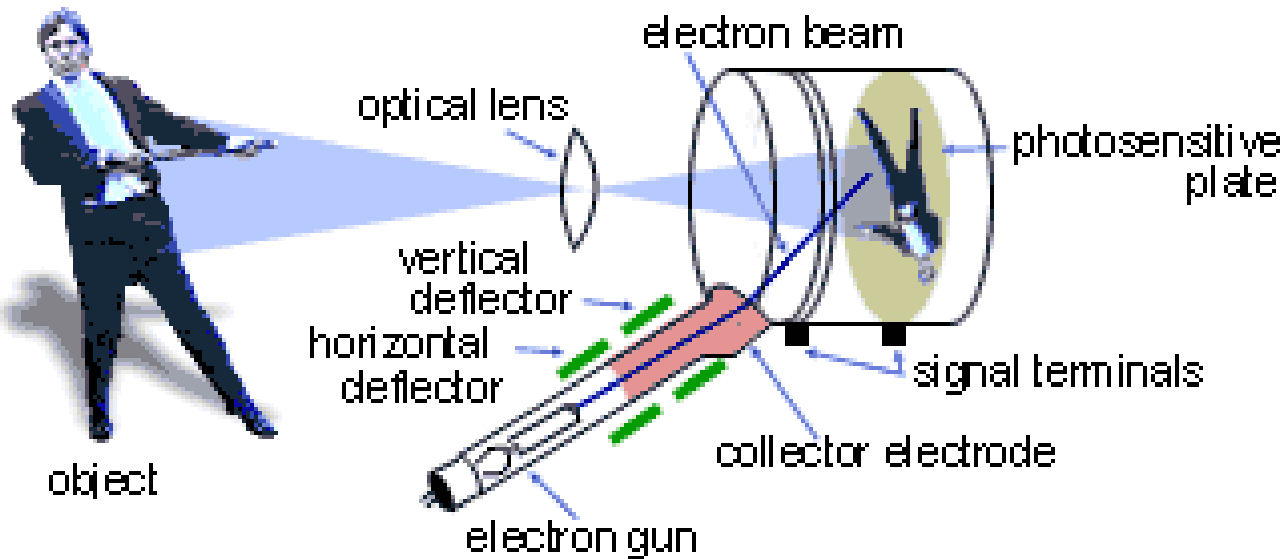

# Television history

- 1972 Teletext experiments in UK
- 1974 First microprocessor used in Broadcast
- 1974 Betamax home VCR
- 1975 Work begin on a digital video standard
- 1986 Sony digital videotape recorder (D-1)
- 1990 All-digital HDTV is proposed
- 1995 First television delivered over the Internet

# Basic black & white television

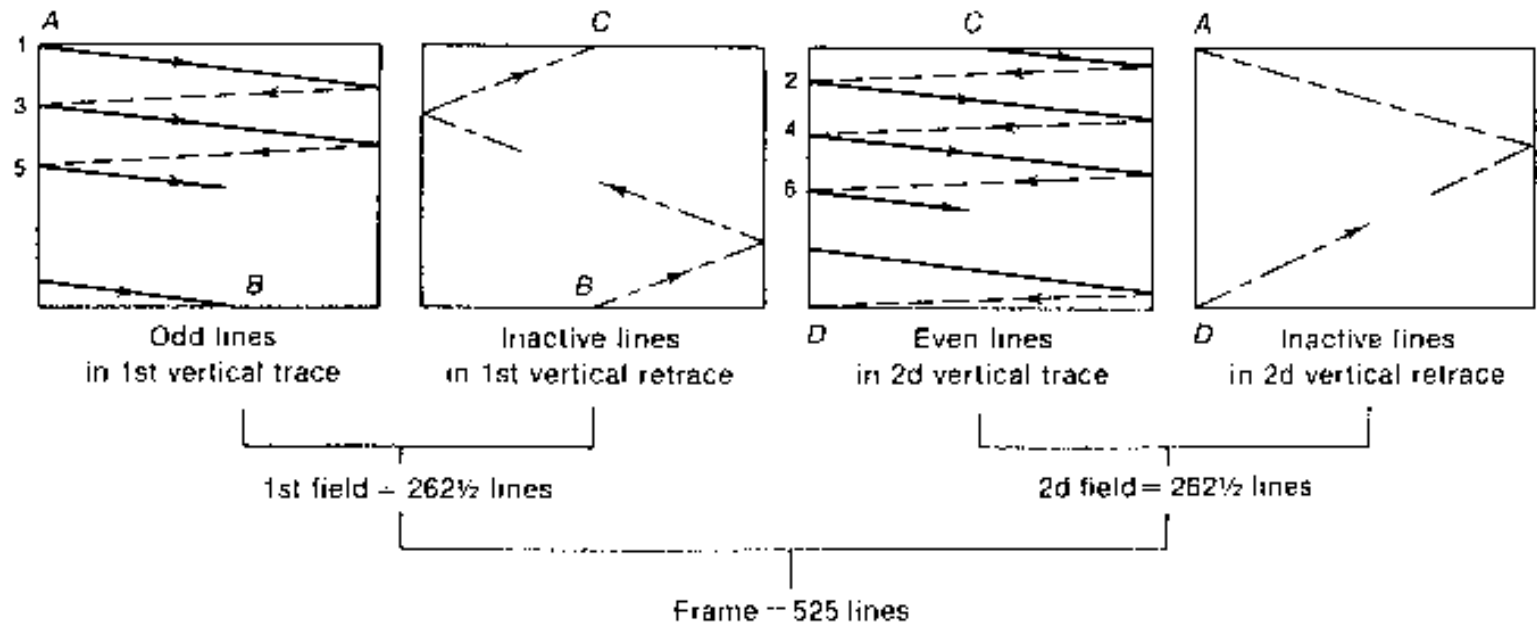
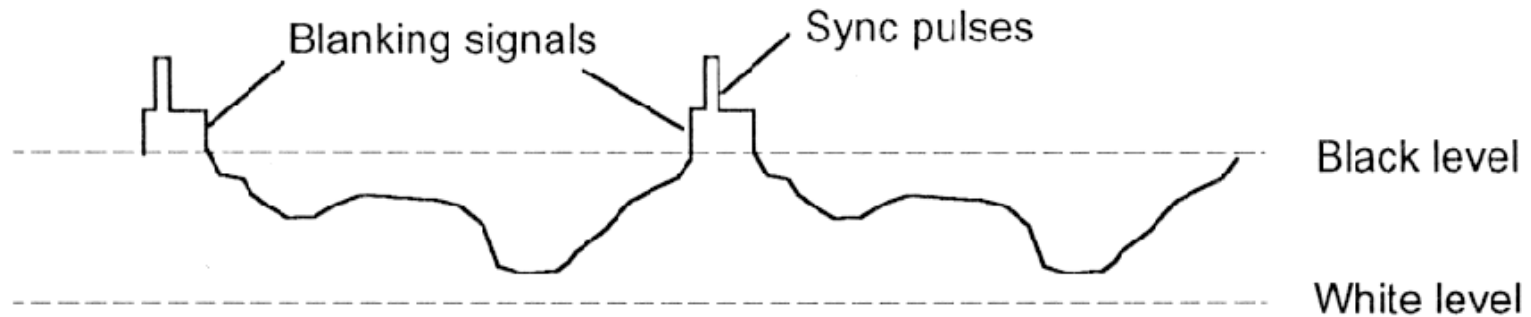

# Video Cassette Recorder

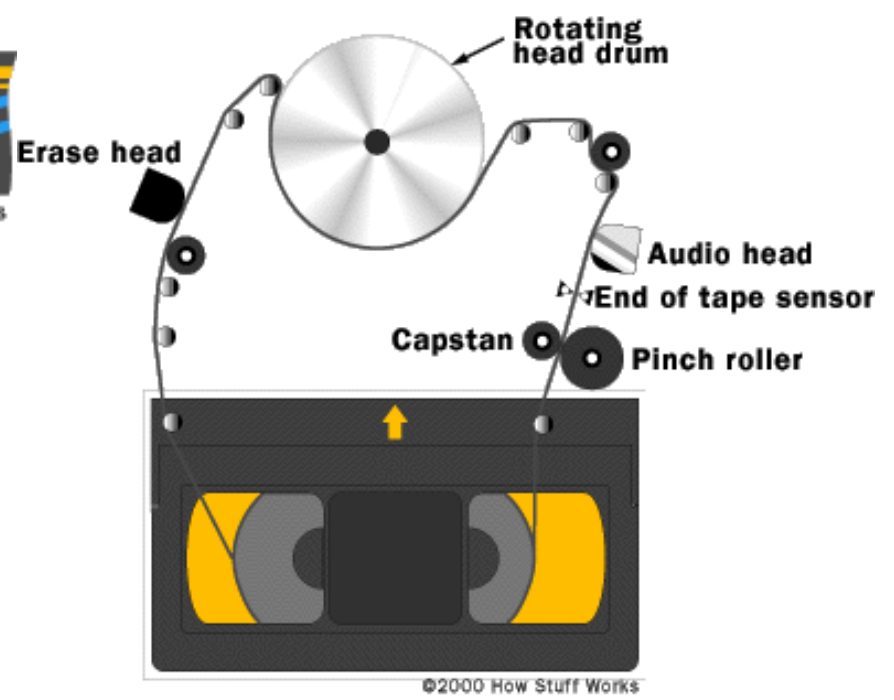
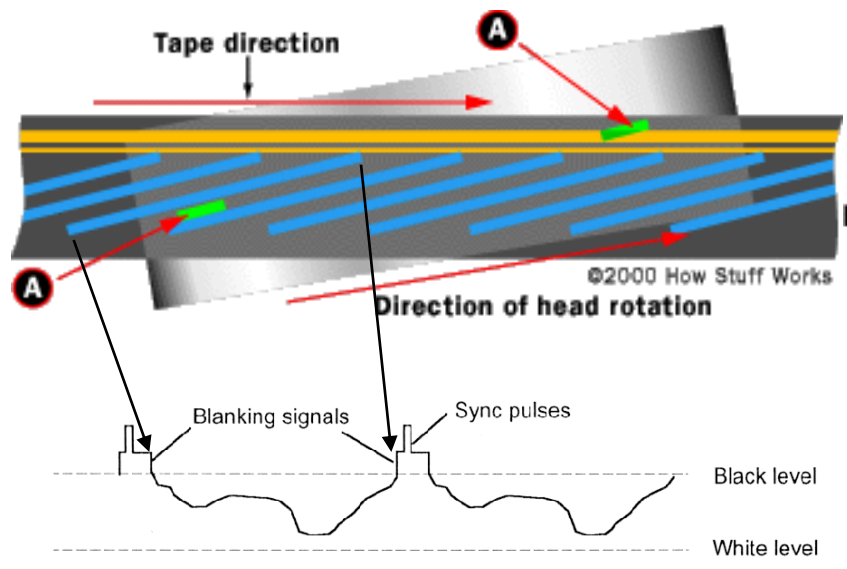

# PAL "M" –system (6 MHz / but comparable with 8 Mhz system)

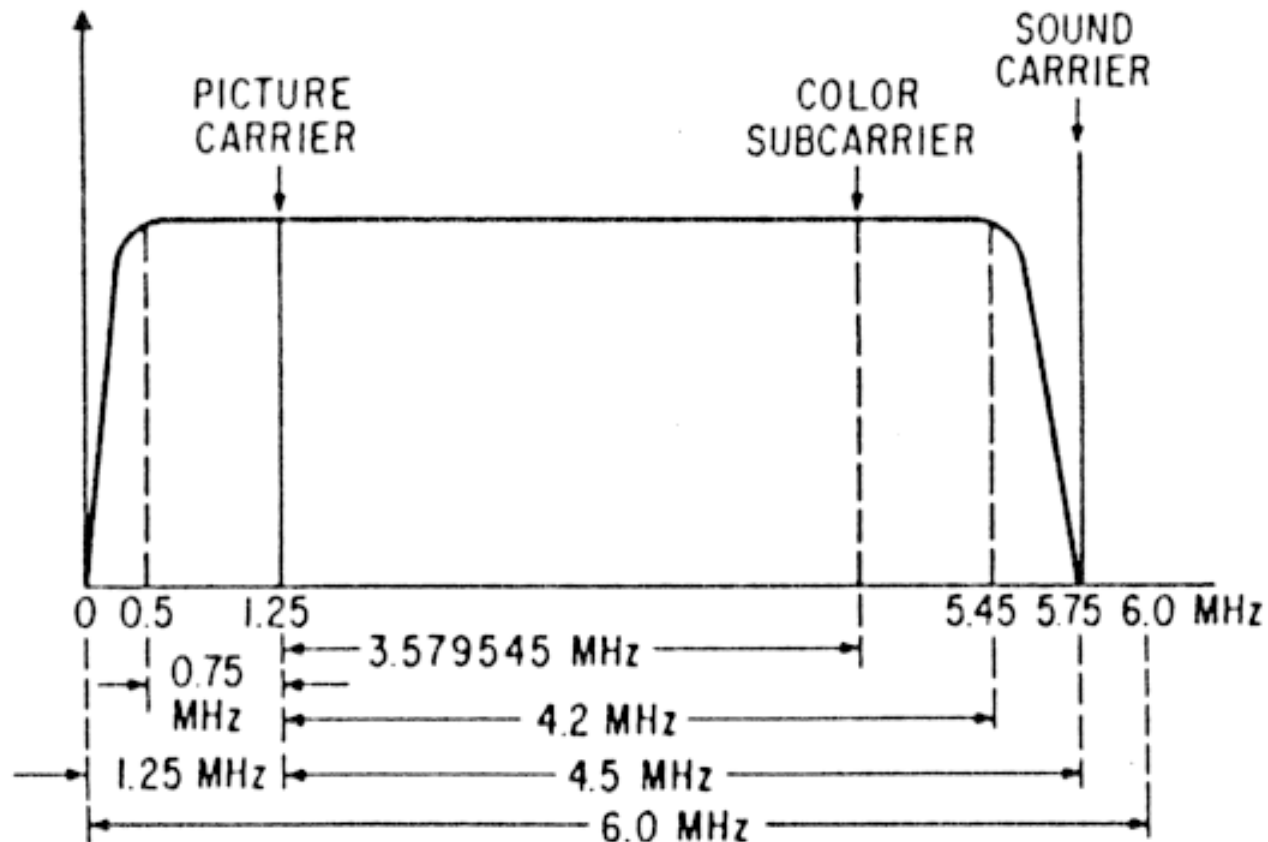



# Color television

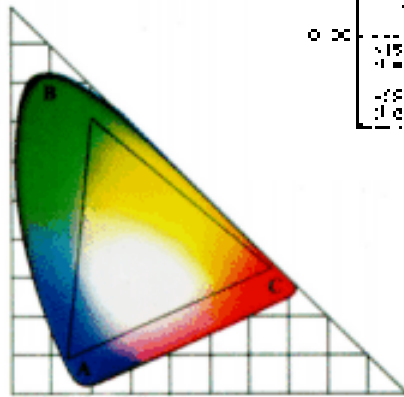
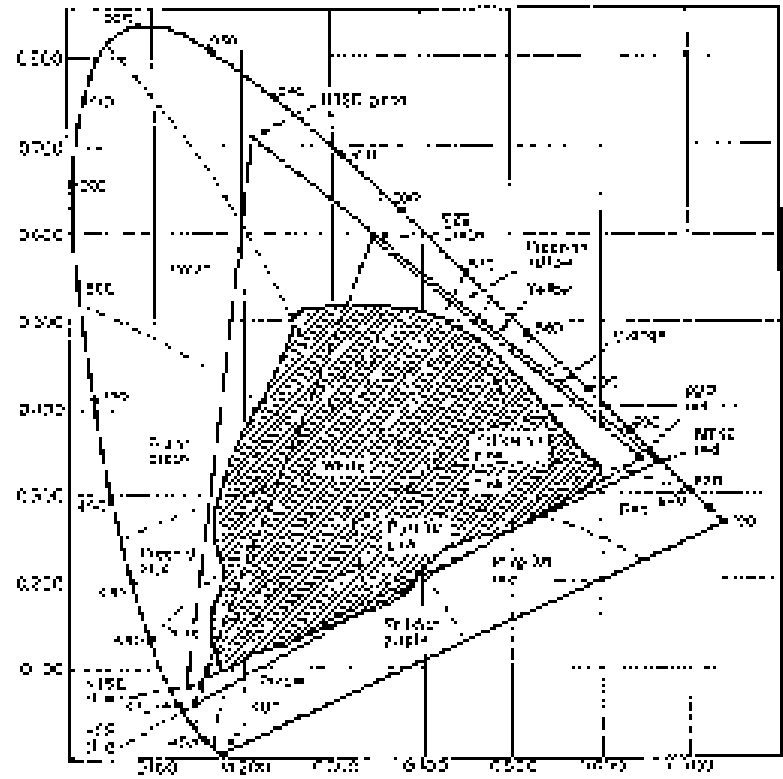
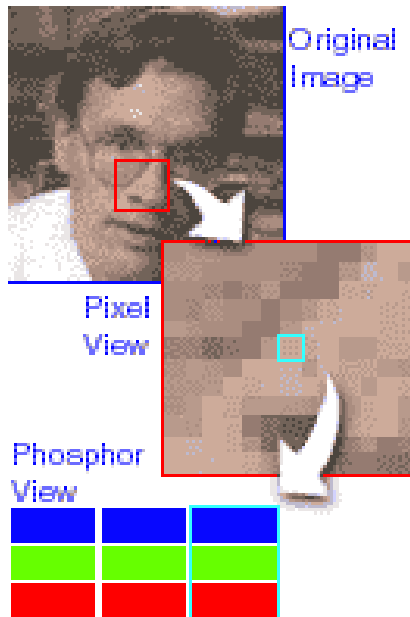

# Color television

## RCA's Color TV System compatible with black and white tvs

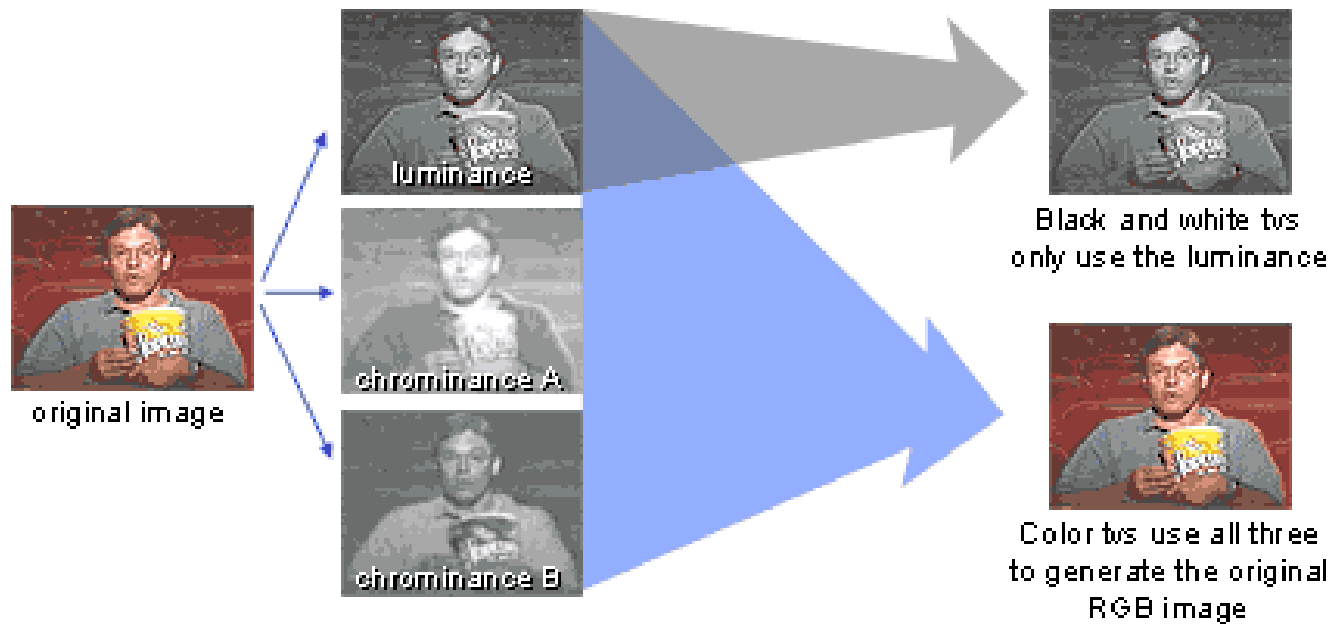

# Color television - B&W compability

Original Red-Green-Blue values RGB separated into:

Luminance – Intensity (3.2 Mhz of 6 MHz)

$$Y = 0.3 R + 0.59 G + 0.11 B$$

Chrominance – Color information (on 3.58 MHz carrier)

$$Q = 0.21 R + 0.52 G + 0.31 B$$

$$I = 0.6 R - 0.28 G - 0.32 B$$

# Color television - B&W compability

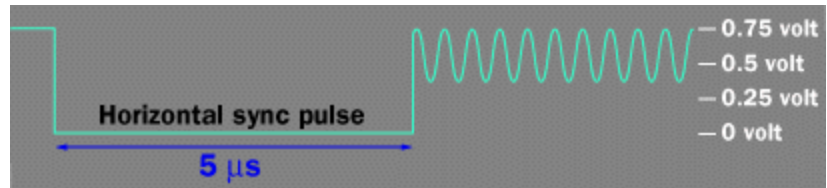

©2000 How Stuff Works

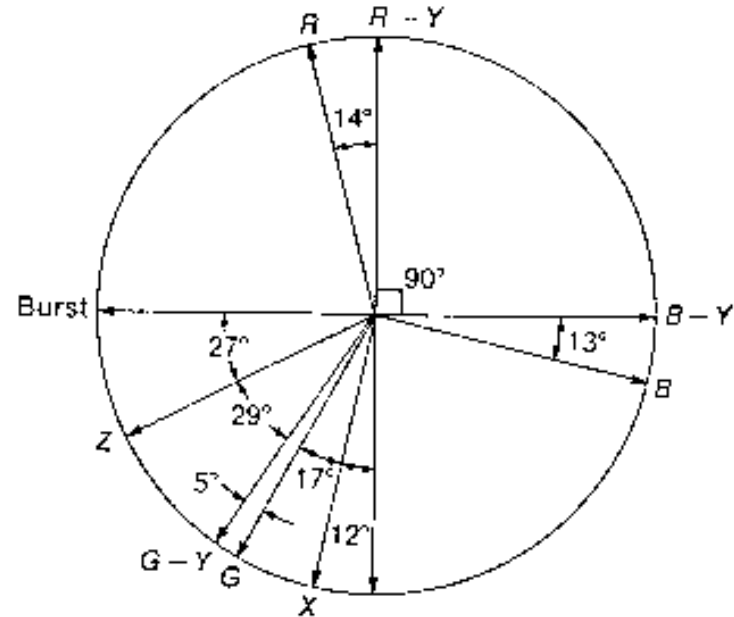
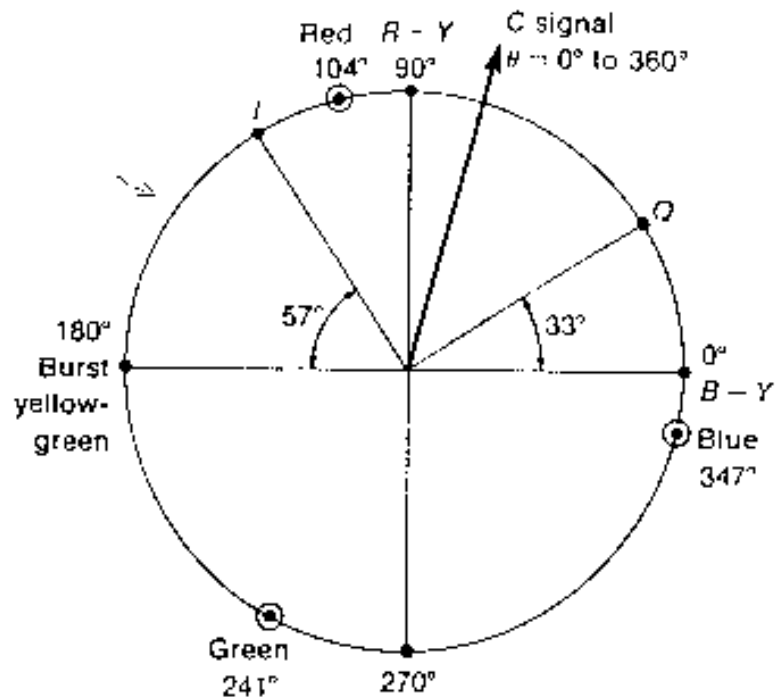

# Receiver block diagram

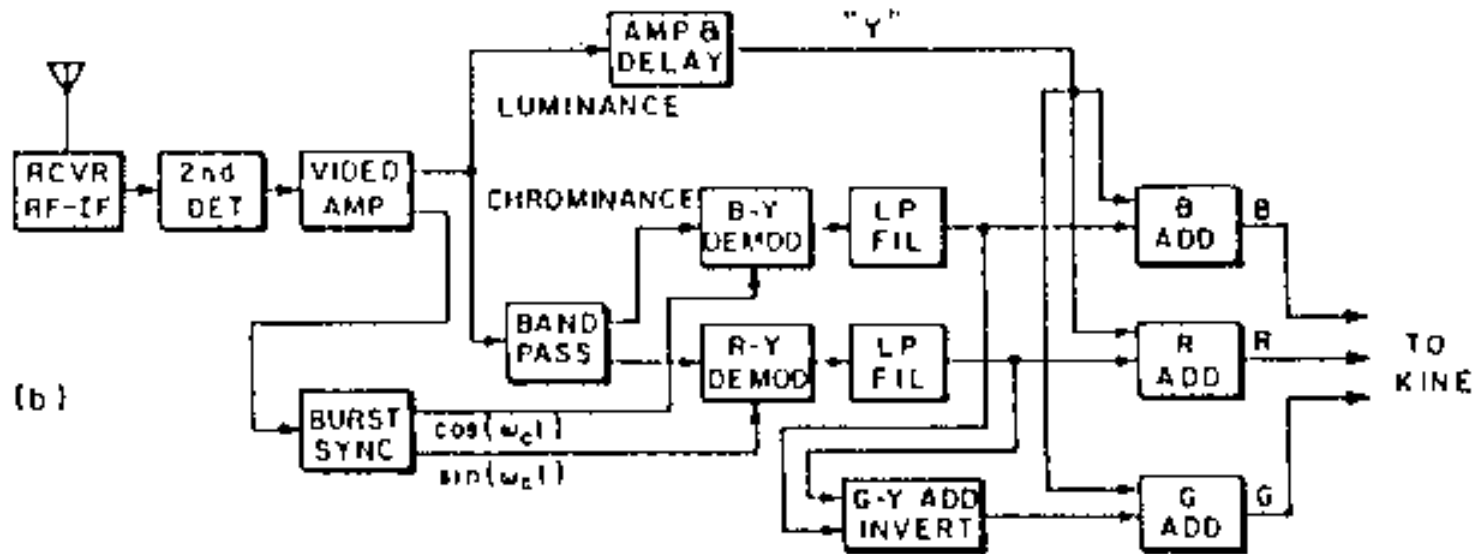

# Analog TV systems

PAL – Phase Alternation Line rate (Main Europe , inc. Finland)

NTSC – National Television Systems Committee (USA & Canada)

SECAM – Sequential Couleur Avec Memoire (France, former Soviet)

	lines	active lines	vertical resolution	aspect ratio	horizontal resolution	frame rate
NTSC	525	484	242	4/3	427	29.94
PAL	625	575	290	4/3	425	25
SECAM	625	575	290	4/3	465	25

# History: Analog TV standards in the world

(old information: Finland and Sweden has switched off the analog services)

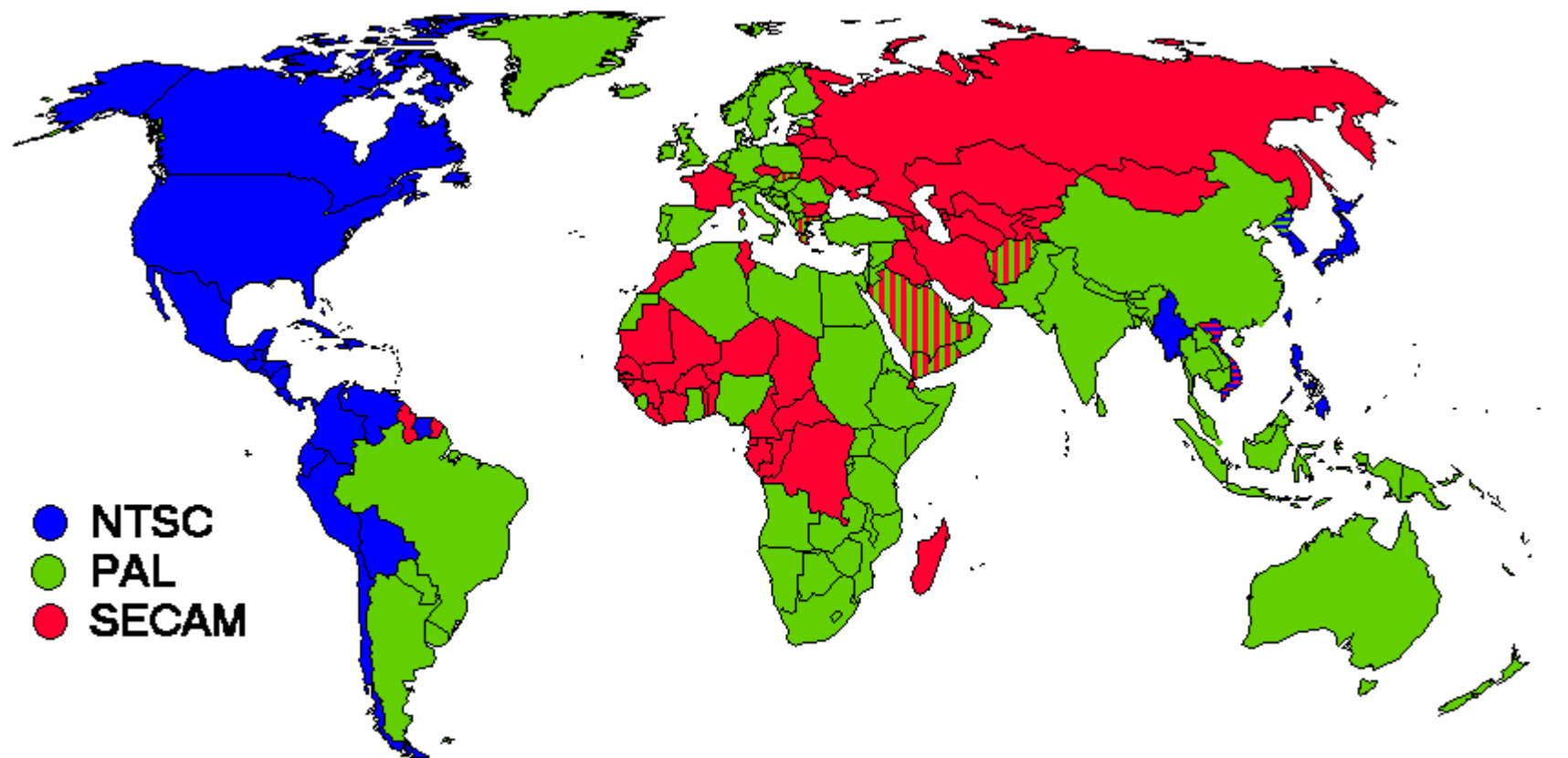

Colour TV Systems of the World 2000

# TV broadcasting

- Terrestrial
  - Roof top antenna
- Cable
  - Modulated on normal channels
- Satellite
  - Modulated on higher frequencies



# Television history – IV generation – digital TV

## Broadcasting technology

1966 OFDM Patent (Chang)  
1992 DVB organization founded  
1994 DVB-C  
1997 DVB-T  
2004 DVB-H  
2005 DVB-S2  
2009 DVB-T2  
2009 DVB-C2  
2012 DVB-NGH

## Content coding technology

1992 MPEG1 approved  
1994 MPEG2 approved  
1998 MPEG4/1 approved  
1999 MPEG4/2 approved  
2003 H.264/MPEG-4 AVC  
2007 SVC Standard  
2013 HEVC (h.265) standard

# DVB broadcasting – basic needs

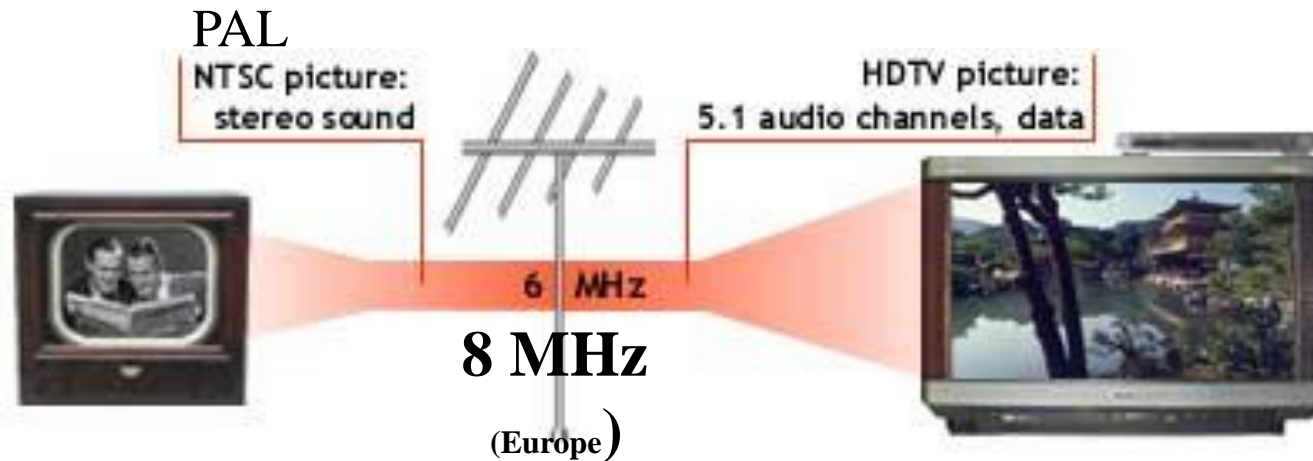

Standard TV ~ 5Mbit / s

HDTV ~ 20 Mbit / s → Today 7-8 Mbit/s using h.264 coding

DVB-T2 4-5 HDTV channels at 7-8 Mbit/s

→ Further increased capacity

→ Advanced video/audio coding

# Uncompressed video rates

- Examples (CCIR [ITU-R] 601)
  - PAL signal: 864x625 resolution, YUV4:2:2  
20bit/pixel colour, 25fps = 270Mbps
  - PAL signal: 864x625 resolution, YUV4:2:2  
16bit/pixel, colour, 25fps = 216Mbps
  - PAL video: 720x576 resolution, YUV4:2:2  
16bit/pixel, colour, 25fps = ~166Mbps  
(~20MB/s, ~1GB/min)
  - HDTV signal 1920x1080, YUV4:2:2  
16bit/pixel, 25 fps = ~830 Mbps
  - DV (Firewire): 400/800Mbps, USB2.0: 480Mbps,  
USB3.0 5 Gbps

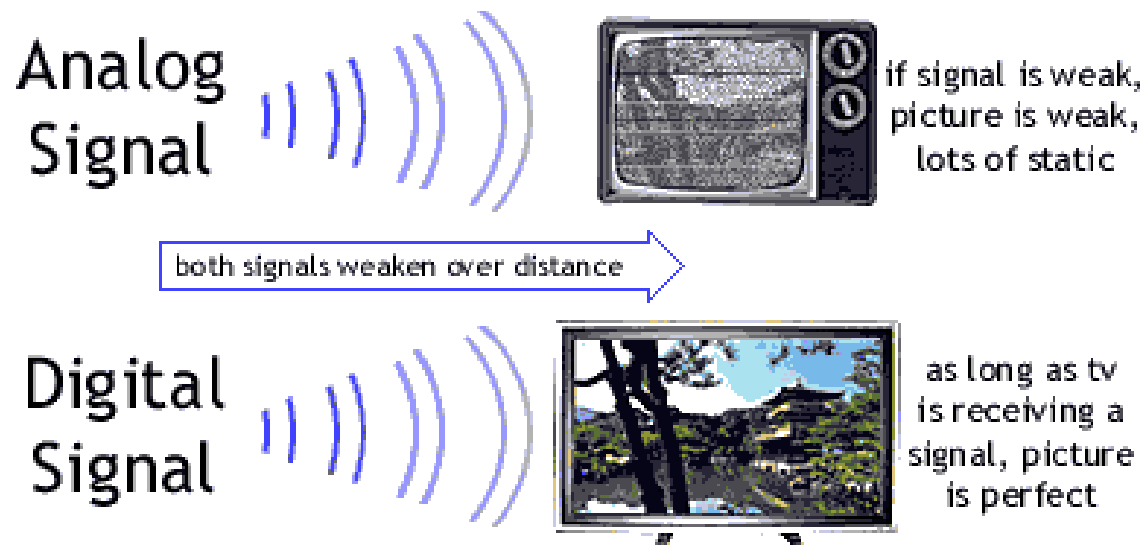

## 4 x 3 aspect ratio

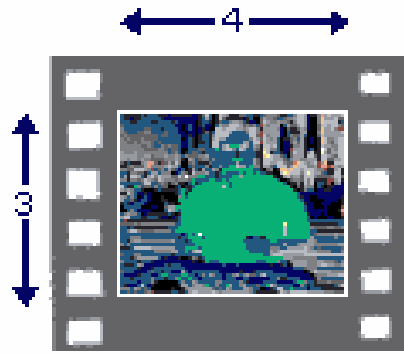

Kinescope film



NTSC standard

## HDTV is 1/3 wider than NTSC

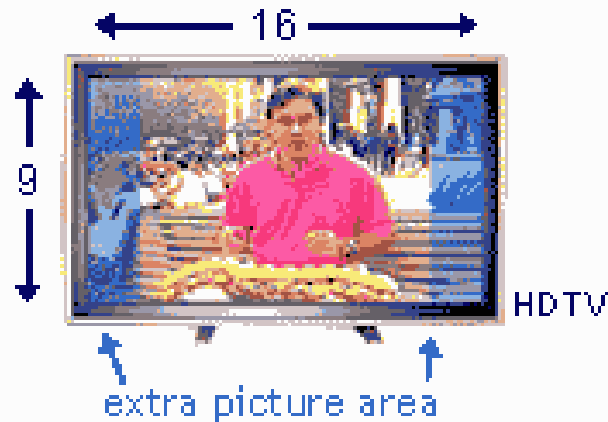

HDTV



NTSC

# MPEG 2 compression

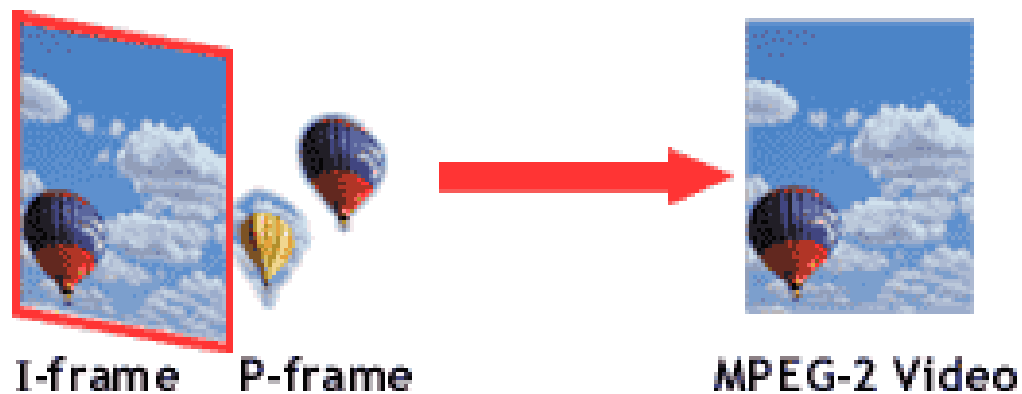

Temporal, spatial compression

# Digital television requirements

- Bandwidth utilization
  - 4-5 PAL quality programs per "channel"
  - Today 4-5 HDTV quality programs per channel
    - Need for new compression techniques
      - MPEG-2, MPEG-4, ....
      - Sound compression
    - Need for new modulation techniques, coding
      - DVB-T/T2: COFDM
      - Convolution codes, LDPC
- Standards
  - EBU, ETSI, DVB